

FOOTING QUANTITIES AND DEPTHS
FROM GROUND LEVEL

ITEM	QTY	HOLE DIAMETER	HOLE DEPTH
CHAIN WALK POST	2	400	600
BALANCE LOG POST	6	400	600
STILT WALKER POST	4	400	800
NET POST	3	400	800
SINGLE LOG STEPPER	9	300	500
TRIPLE LOG STEPPER	1	400	500

NOTE:

- THIS PRODUCT IS DESIGNED FOR 300MM SOFT FALL. CHECK THE PROPOSED ON SITE SOFT FALL DEPTH. IF IT IS NOT 300MM PLEASE ADJUST DEPTHS OF POST HOLES ACCORDINGLY, TO ACHIEVE CORRECT OVERALL SUBSURFACE DEPTH. THIS WILL MAINTAIN CORRECT HEIGHT OF EQUIPMENT ABOVE UNDERSURFACE LEVEL.

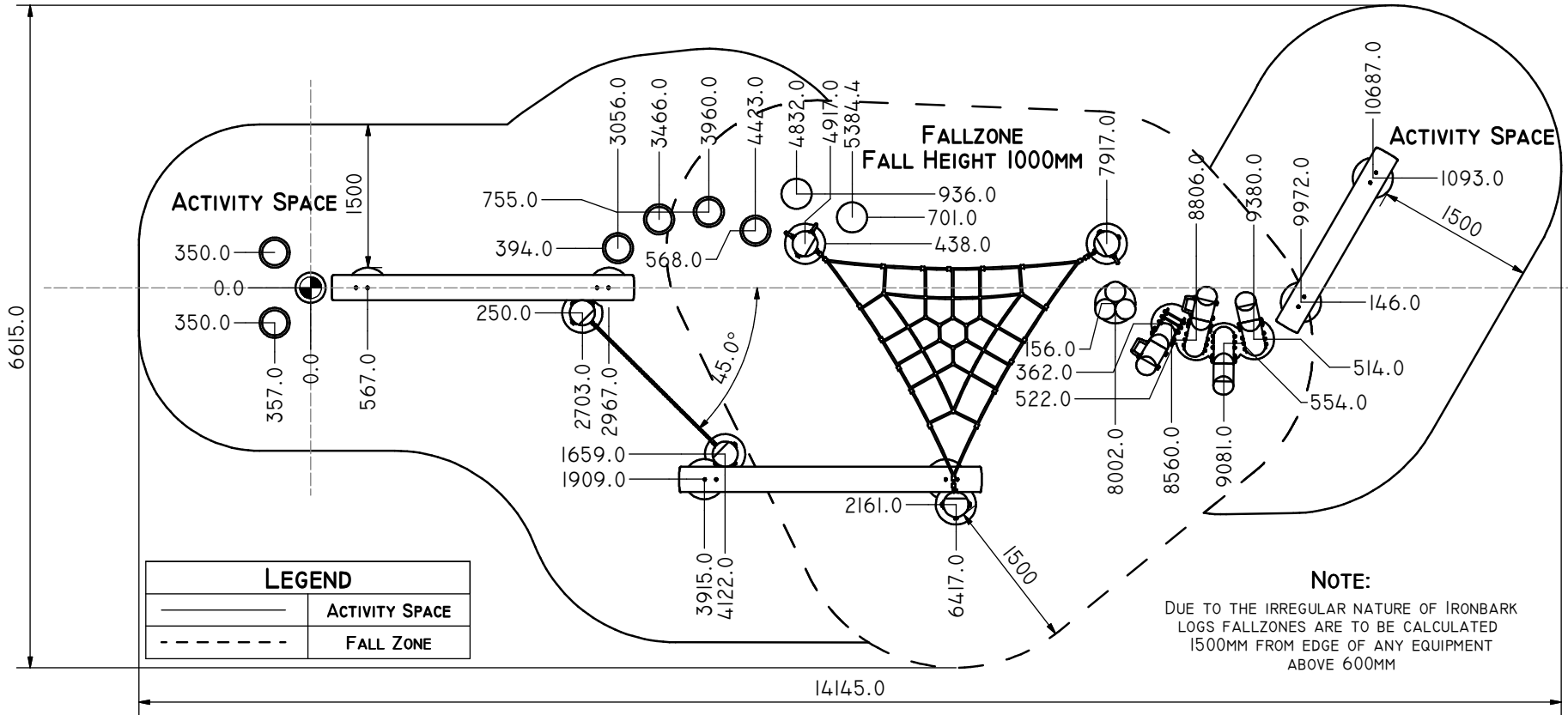

LEGEND	
	ACTIVITY SPACE
	FALL ZONE

JOB N°	PLANNED BY		UNLESS STATED OTHERWISE - ALL DIMENSIONS ARE IN MILLIMETRES.		natura
	PLAN DATE		GENERAL TOLERANCES: DIN ISO 2768-MK		
JOB NAME	MADE BY	DRAWN	BV	ITEM N°	SF LOG OBSTACLE COURSE
		DATE	17/10/2023	A-NAT-2237	
	MFG DATE	CHECKED		STOCK / LEGACY N°	
		DATE		PNI455	A-NAT-2237-001

© 2024 THE PLAY COLLECTIVE ABN 28 101 472 619. THE INFORMATION CONTAINED IN THIS DRAWING IS THE SOLE PROPERTY OF THE PLAY COLLECTIVE. ANY REPRODUCTION IN PART OR WHOLE WITHOUT THE WRITTEN PERMISSION OF THE PLAY COLLECTIVE IS PROHIBITED. ANY UNCERTAIN DIMENSIONS ARE TO BE CONFIRMED BY PLAY COLLECTIVE BEFORE COMMENCEMENT OF MANUFACTURING.

REV	SCALE: NTS	SHT 1 OF 6	A3
-----	------------	------------	----

FOOTING QUANTITIES AND DEPTHS
FROM GROUND LEVEL

ITEM	QTY	HOLE DIAMETER	HOLE DEPTH
CHAIN WALK POST	2	400	600
BALANCE LOG POST	6	400	600
STILT WALKER POST	4	400	800
NET POST	3	400	800
SINGLE LOG STEPPER	9	300	500
TRIPLE LOG STEPPER	1	400	500

NOTE:

- THIS PRODUCT IS DESIGNED FOR 300MM SOFT FALL. CHECK THE PROPOSED ON SITE SOFT FALL DEPTH. IF IT IS NOT 300MM PLEASE ADJUST DEPTHS OF POST HOLES ACCORDINGLY, TO ACHIEVE CORRECT OVERALL SUBSURFACE DEPTH. THIS WILL MAINTAIN CORRECT HEIGHT OF EQUIPMENT ABOVE UNDERSURFACE LEVEL.

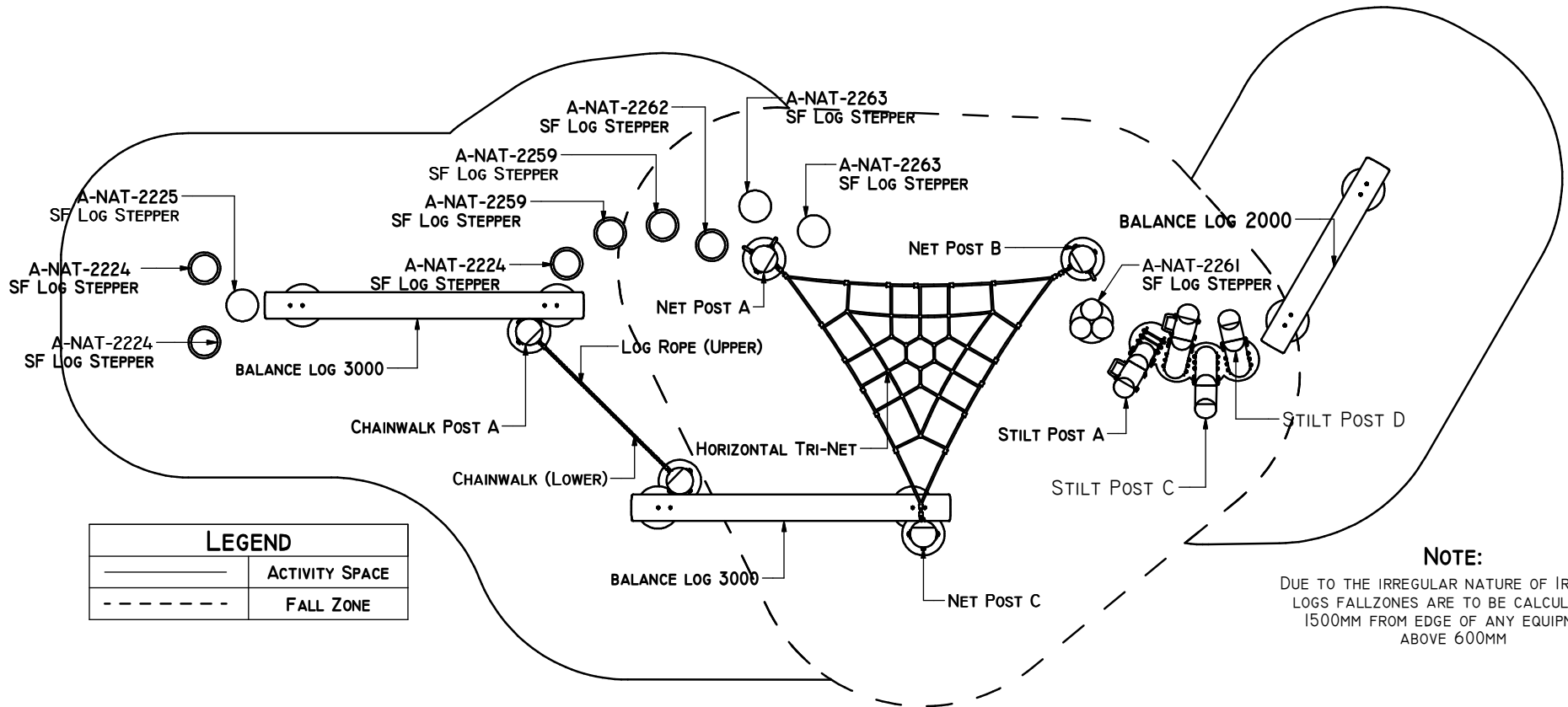

LEGEND	
	ACTIVITY SPACE
	FALL ZONE



NOTE:
DUE TO THE IRREGULAR NATURE OF IRONBARK LOGS FALLZONES ARE TO BE CALCULATED 1500MM FROM EDGE OF ANY EQUIPMENT ABOVE 600MM

JOB N°	PLANNED BY		UNLESS STATED OTHERWISE - ALL DIMENSIONS ARE IN MILLIMETRES.		
	PLAN DATE		GENERAL TOLERANCES: DIN ISO 2768-MK		
JOB NAME	MADE BY	DRAWN	BV	ITEM N°	SF Log Obstacle Course
		DATE	17/10/2023	A-NAT-2237	
	MFG DATE	CHECKED		STOCK / LEGACY N°	
		DATE		PNI455	DRAWING N°
© 2024 THE PLAY COLLECTIVE ABN 28 101 472 619. THE INFORMATION CONTAINED IN THIS DRAWING IS THE SOLE PROPERTY OF THE PLAY COLLECTIVE. ANY REPRODUCTION IN PART OR WHOLE WITHOUT THE WRITTEN PERMISSION OF THE PLAY COLLECTIVE IS PROHIBITED. ANY UNCERTAIN DIMENSIONS ARE TO BE CONFIRMED BY PLAY COLLECTIVE BEFORE COMMENCEMENT OF MANUFACTURING.					A-NAT-2237-002
REV	SCALE: NTS	SHT	2 OF 6	A3	

NOTE:

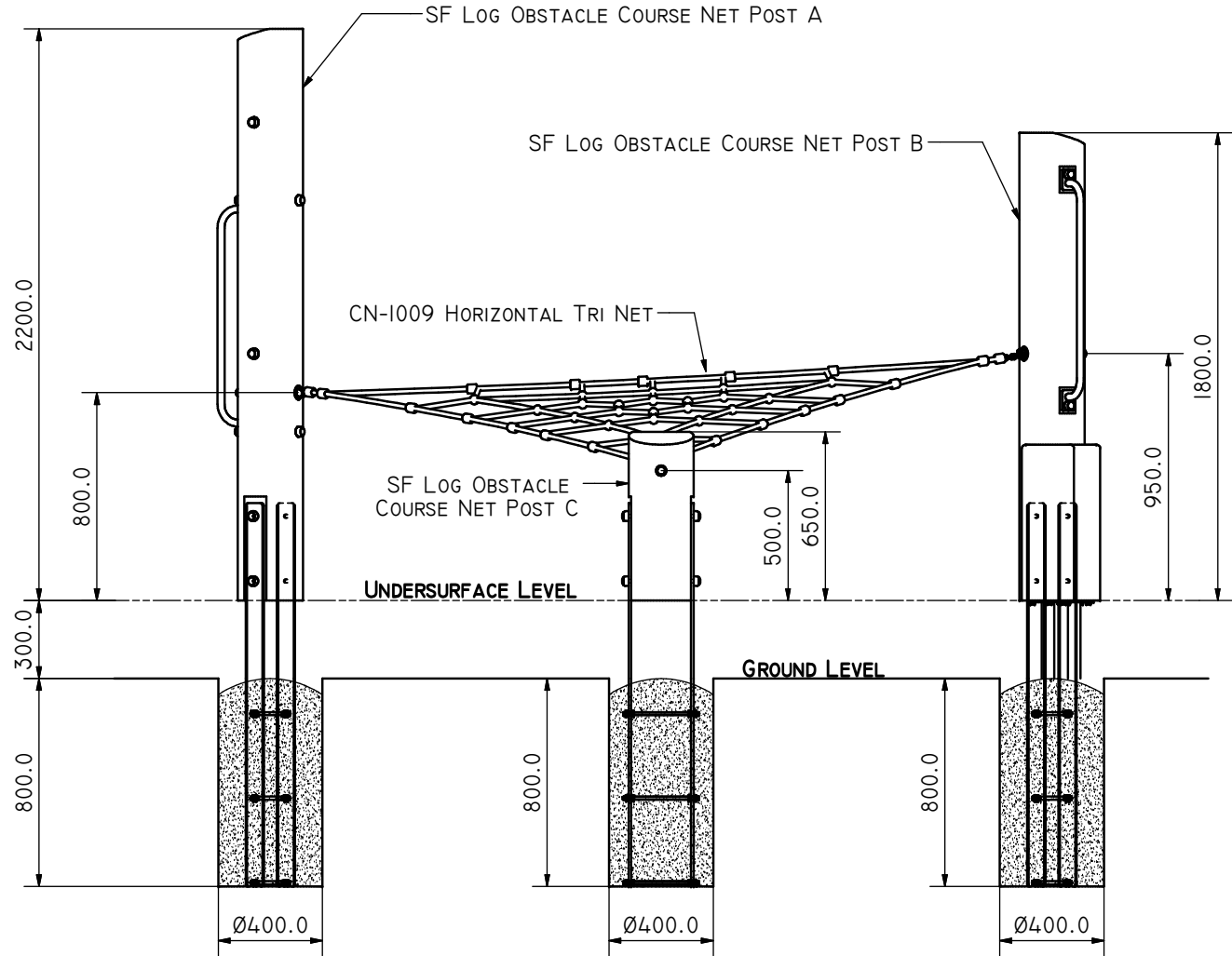
- THIS PRODUCT IS DESIGNED FOR 300MM SOFT FALL. CHECK THE PROPOSED ON SITE SOFT FALL DEPTH. IF IT IS NOT 300MM PLEASE ADJUST DEPTHS OF POST HOLES ACCORDINGLY, TO ACHIEVE CORRECT OVERALL SUBSURFACE DEPTH. THIS WILL MAINTAIN CORRECT HEIGHT OF EQUIPMENT ABOVE UNDERSURFACE LEVEL.





JOB N°	PLANNED BY		UNLESS STATED OTHERWISE - ALL DIMENSIONS ARE IN MILLIMETRES.			
	PLAN DATE		GENERAL TOLERANCES: DIN ISO 2768-MK			
JOB NAME	MADE BY	DRAWN	BV	ITEM N°	SF Log Obstacle Course	
		DATE	17/10/2023	A-NAT-2237		
	MFG DATE	CHECKED		STOCK / LEGACY N°		
				PNI455	DRAWING N°	A-NAT-2237-003
<small>© 2024 THE PLAY COLLECTIVE ABN 28 101 472 619. THE INFORMATION CONTAINED IN THIS DRAWING IS THE SOLE PROPERTY OF THE PLAY COLLECTIVE. ANY REPRODUCTION IN PART OR WHOLE WITHOUT THE WRITTEN PERMISSION OF THE PLAY COLLECTIVE IS PROHIBITED. ANY UNCERTAIN DIMENSIONS ARE TO BE CONFIRMED BY PLAY COLLECTIVE BEFORE COMMENCEMENT OF MANUFACTURING.</small>						
REV	SCALE: NTS	SHT	3 OF 6	A3		

NOTE:

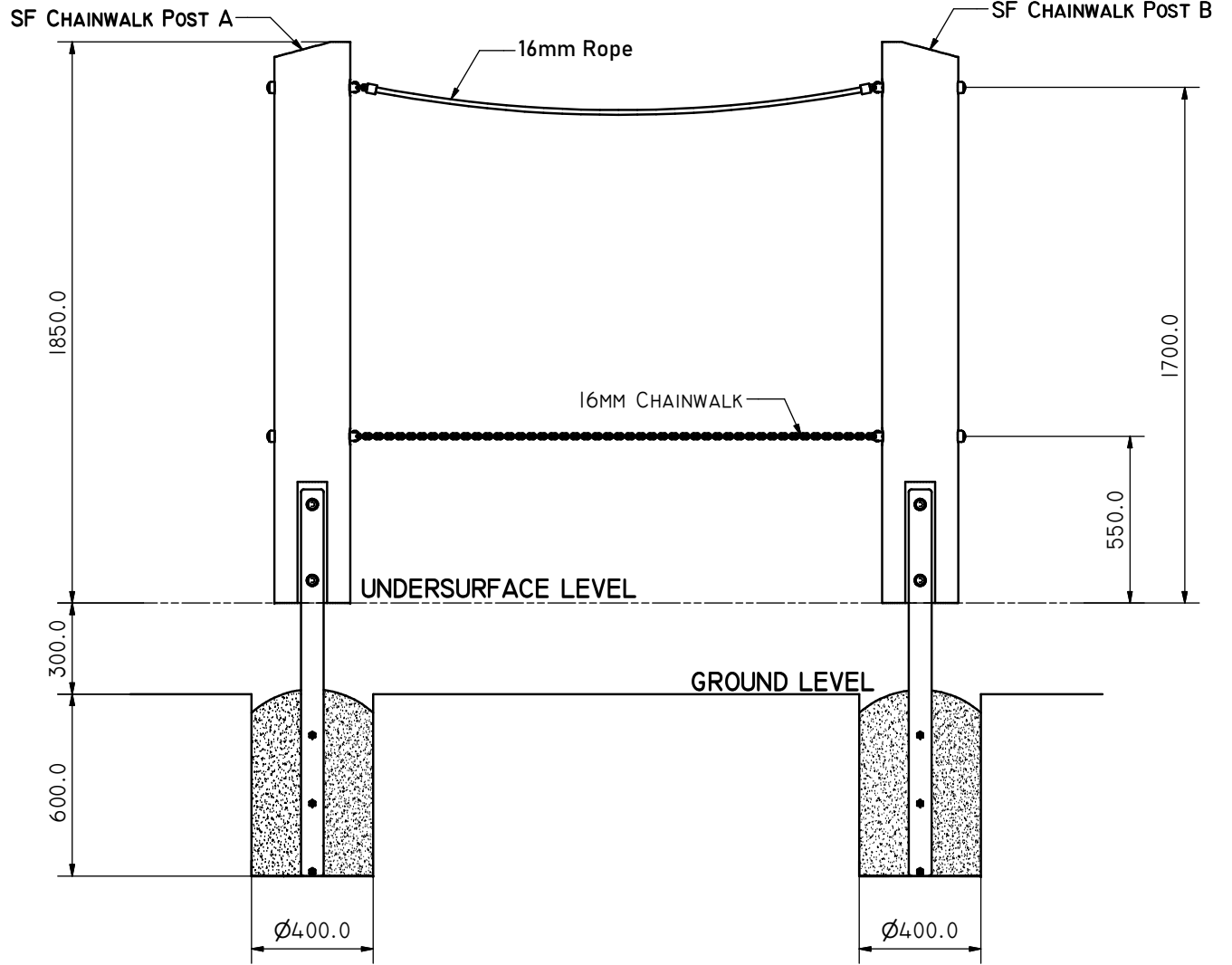
- THIS PRODUCT IS DESIGNED FOR 300MM SOFT FALL. CHECK THE PROPOSED ON SITE SOFT FALL DEPTH. IF IT IS NOT 300MM PLEASE ADJUST DEPTHS OF POST HOLES ACCORDINGLY, TO ACHIEVE CORRECT OVERALL SUBSURFACE DEPTH. THIS WILL MAINTAIN CORRECT HEIGHT OF EQUIPMENT ABOVE UNDERSURFACE LEVEL.



JOB N°	PLANNED BY		UNLESS STATED OTHERWISE - ALL DIMENSIONS ARE IN MILLIMETRES.				
	PLAN DATE		GENERAL TOLERANCES: DIN ISO 2768-MK				
JOB NAME	MADE BY	DRAWN	BV	ITEM N°	SF Log OBSTACLE COURSE		
		DATE	17/10/2023	A-NAT-2237			
	MFG DATE	CHECKED		STOCK / LEGACY N°			
				PNI455	DRAWING N°	A-NAT-2237-004	
© 2024 THE PLAY COLLECTIVE ABN 28 101 472 619. THE INFORMATION CONTAINED IN THIS DRAWING IS THE SOLE PROPERTY OF THE PLAY COLLECTIVE. ANY REPRODUCTION IN PART OR WHOLE WITHOUT THE WRITTEN PERMISSION OF THE PLAY COLLECTIVE IS PROHIBITED. ANY UNCERTAIN DIMENSIONS ARE TO BE CONFIRMED BY PLAY COLLECTIVE BEFORE COMMENCEMENT OF MANUFACTURING.				REV	SCALE: NTS	SHT 4 OF 6	A3

NOTE:

THIS PRODUCT IS DESIGNED FOR 300MM SOFT FALL. CHECK THE PROPOSED ON SITE SOFT FALL DEPTH. IF IT IS NOT 300MM PLEASE ADJUST DEPTHS OF POST HOLES ACCORDINGLY, TO ACHIEVE CORRECT OVERALL SUBSURFACE DEPTH. THIS WILL MAINTAIN CORRECT HEIGHT OF EQUIPMENT ABOVE UNDERSURFACE LEVEL.

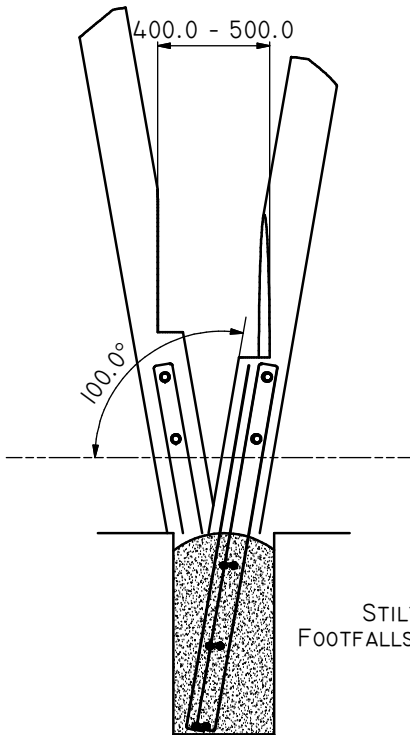

NOTE:
STILT POSTS INSTALL AT 10 DEGREES TO VERTICAL.
FOOTFALLS VARIES FROM 400MM - 500MM SPACING NOMINALLY.

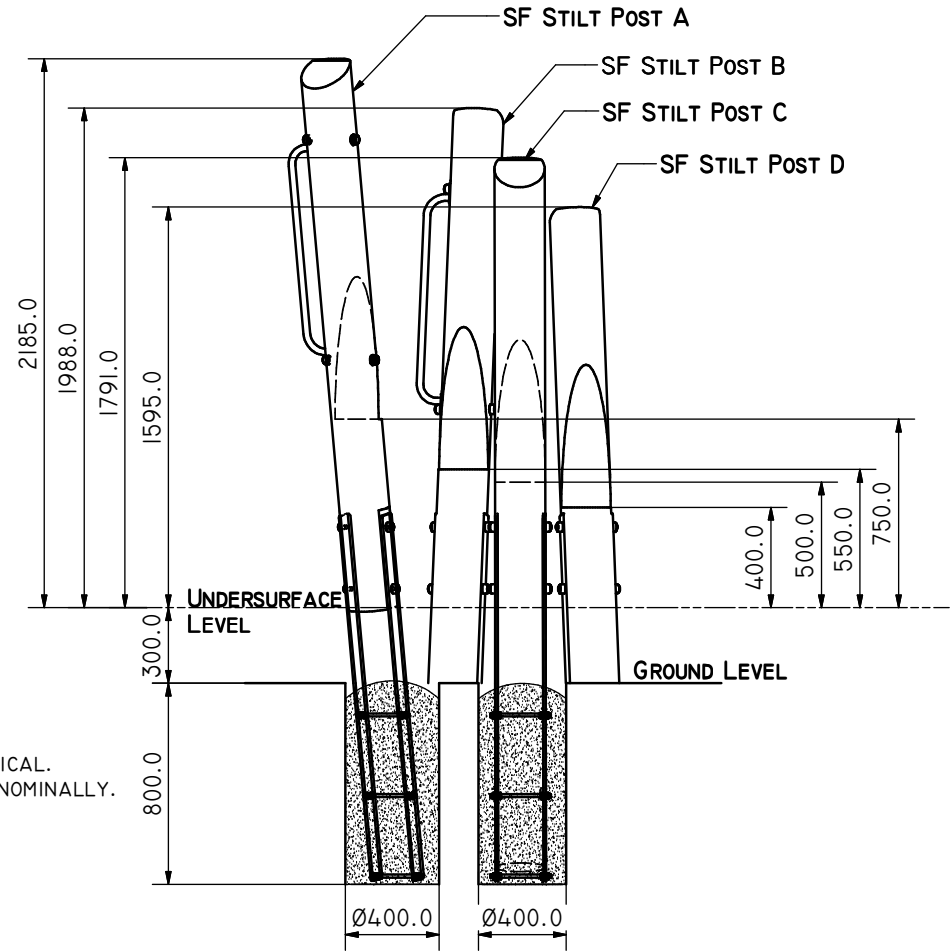



JOB N°	PLANNED BY	UNLESS STATED OTHERWISE - ALL DIMENSIONS ARE IN MILLIMETRES. GENERAL TOLERANCES: DIN ISO 2768-MK			
	PLAN DATE				
JOB NAME	MADE BY	DRAWN	BV	ITEM N°	
		DATE	17/10/2023	A-NAT-2237	
	MFG DATE	CHECKED		STOCK / LEGACY N°	
		DATE		PNI455	
			DRAWING N°	A-NAT-2237-005	
© 2024 THE PLAY COLLECTIVE ABN 28 101 472 619. THE INFORMATION CONTAINED IN THIS DRAWING IS THE SOLE PROPERTY OF THE PLAY COLLECTIVE. ANY REPRODUCTION IN PART OR WHOLE WITHOUT THE WRITTEN PERMISSION OF THE PLAY COLLECTIVE IS PROHIBITED. ANY UNCERTAIN DIMENSIONS ARE TO BE CONFIRMED BY PLAY COLLECTIVE BEFORE COMMENCEMENT OF MANUFACTURING.		REV	SCALE: NTS	SHT 5 OF 6	A3

NOTE:

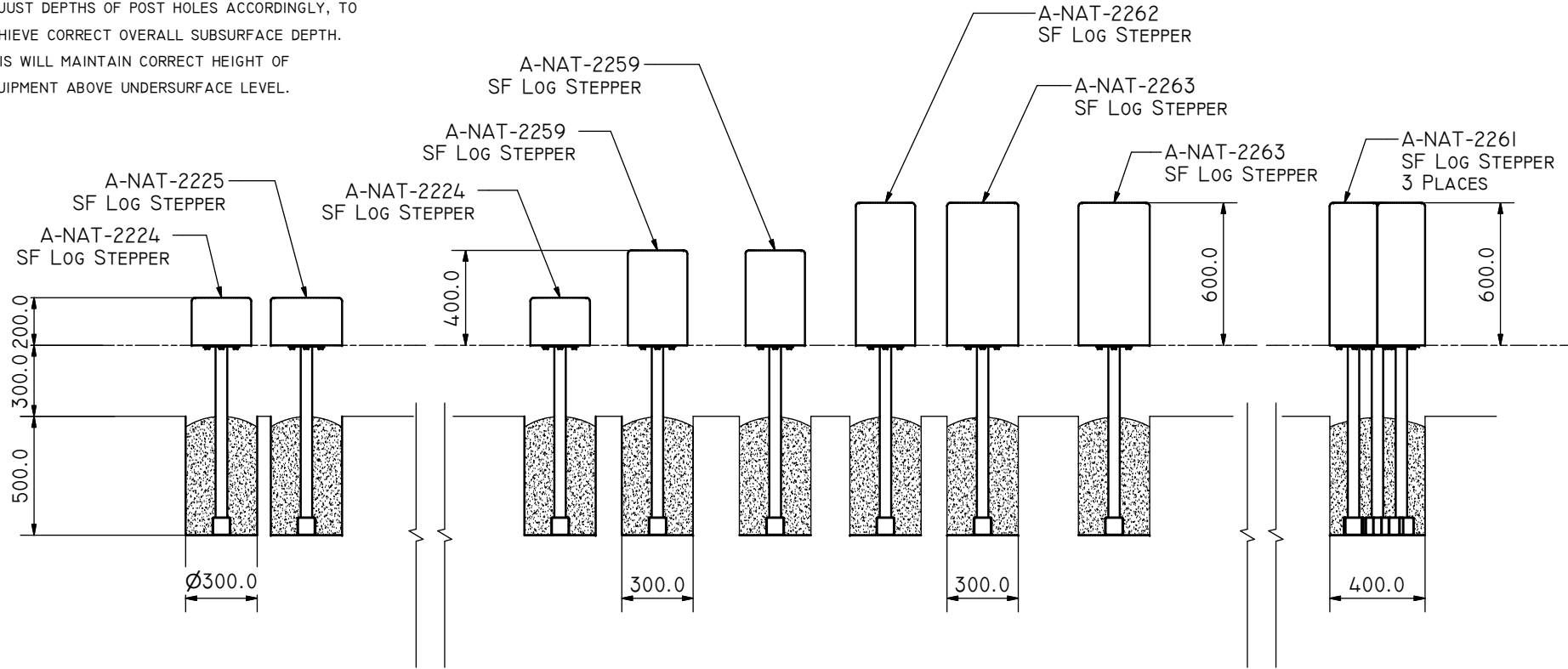
THIS PRODUCT IS DESIGNED FOR 300MM SOFT FALL. CHECK THE PROPOSED ON SITE SOFT FALL DEPTH. IF IT IS NOT 300MM PLEASE ADJUST DEPTHS OF POST HOLES ACCORDINGLY, TO ACHIEVE CORRECT OVERALL SUBSURFACE DEPTH. THIS WILL MAINTAIN CORRECT HEIGHT OF EQUIPMENT ABOVE UNDERSURFACE LEVEL.



JOB N°	PLANNED BY		UNLESS STATED OTHERWISE - ALL DIMENSIONS ARE IN MILLIMETRES.			
	PLAN DATE		GENERAL TOLERANCES: DIN ISO 2768-MK			
JOB NAME	MADE BY	DRAWN	BV	ITEM N°	SF Log OBSTACLE COURSE	
		DATE	17/10/2023	A-NAT-2237		
	MFG DATE	CHECKED		STOCK / LEGACY N°		
				PNI455	DRAWING N°	A-NAT-2237-006
© 2024 THE PLAY COLLECTIVE ABN 28 101 472 619. THE INFORMATION CONTAINED IN THIS DRAWING IS THE SOLE PROPERTY OF THE PLAY COLLECTIVE. ANY REPRODUCTION IN PART OR WHOLE WITHOUT THE WRITTEN PERMISSION OF THE PLAY COLLECTIVE IS PROHIBITED. ANY UNCERTAIN DIMENSIONS ARE TO BE CONFIRMED BY PLAY COLLECTIVE BEFORE COMMENCEMENT OF MANUFACTURING.		REV	SCALE: NTS	SHT 6 OF 6	A3	